



Grupo
ABRESSA
A B R A S I V O S

catálogo general de producto
general product catalogue



The **ABRESSA GROUP** is dedicated to the manufacture and distribution of all kinds of abrasive bricks for polishing natural and artificial stone. For more than 30 years the group has been the world leader in its field and can offer the best solutions for any problem faced by our customers.

Thanks to continuous expansion and growth, dedicated to the aim of providing the best support, the ABRESSA group comprises 4 companies:

- **ABRASIVOS DE ESPAÑA, S.A.** (1970). The original company, located in Barcelona (Les Franqueses del Vallés). Total surface of 10.000 m², supplies to whole Europe.
- **ABRESSA CERÁMICA, S.A.** (1989). Mollet del Vallés (Barcelona). Specialized in products for ceramics.
- **ABRESSA CANADA, INC.** (1988). Québec (San Sebastián). Supplies mainly to the American continent and to the Indian market.
- **ABRASIVOS DE PORTUGAL LDA.** (1992). Portugal (Vila Nova de Cerveira), 12.000 m². Supplies to the rest of the world.

One of our strengths within the **ABRESSA GROUP** is the high **QUALITY** standard and our constant drive for innovation and improvement that has been a part of the ethos in the group from the very beginning. This has made us a leading brand all over the world. We have committed ourselves to increase our human and technological resources for research and development (R&D) and to continuously modernise our installations, equipment and production methods in order to adapt to the permanent technological evolution by the introduction of special products.

The environment is extremely important to us. We have put a great deal of effort into reducing waste to virtually zero and work well within legislated levels as well as making steady improvements to our production and logistical processes.

The result of this dedication is **ISO 9001:2000 certificate of Quality and ISO 14001:1996 certificate of Environment**.

Our main objective is to continue working in this business for our existing and new customers, offering the best **QUALITY, PROFESSIONALITY and SERVICE** so that we maintain our lead and can face the future with great confidence.

Le **GRUPE ABRESSA**, consacré à la fabrication et commercialisation de tout type de meules abrasives pour le polissage de pierres ornementales et artificielle, se consolide depuis plus de 30 ans comme leader mondial dans son secteur, répondant à n'importe quel problème soumis par nos clients.

Grâce à son expansion continue et développement, et avec l'objectif de fournir et donner le meilleur service, le Groupe est formé par les entreprises suivantes :

- **ABRASIVOS DE ESPAÑA, S.A.** (1970). Compagnie mère située à Les Franqueses del Valles (Barcelone). Surface de 10.000 m². Fournit le marché espagnol et européen.
- **ABRESSA CERÁMICA, S.A.** (1989). Mollet del Valles (Barcelone), spécialisée en produits céramiques.
- **ABRESSA CANADA, INC.** (1988). Saint Sébastien (Québec). Fournit le continent américain et le marché indien.
- **ABRASIVOS DE PORTUGAL LDA.** (1992). Vila Nova de Cerveira (Portugal). 12.000 m² de surface. Fournit le reste des marchés mondiaux.

Les points forts et piliers de base du **GRUPE ABRESSA**, sont le standard de **QUALITÉ** et l'esprit d'innovation et d'amélioration continue qui dirigent le Groupe depuis ses débuts. Ces aspects ont valu à notre marque un grand prestige à travers le monde. Nous misons sur l'investissement constant en ressources technologiques et humaines dans le secteur de la recherche et développement (R&D) et la continue modernisation de nos équipements, installations et méthodes de production afin de répondre à la permanente évolution technologique qui existe dans nos secteurs moyennant l'introduction de produits spécialisés.

Une autre de nos préoccupations est le souci de l'environnement. Nous réalisons un important effort économique et humain pour réduire presque à zéro les résidus et nous situer dans les entreprises les plus conscientisées au point de vue écologique. Nous travaillons quotidiennement à l'exécution des normes des risques au travail ainsi qu'à l'amélioration des procédés de production et d'organisation. Nous avons obtenu les certifications **ISO 9001 :2000 de Qualité et ISO 14001 :1996 d'Environnement**.

Notre objectif principal est celui de continuer d'offrir **QUALITÉ** maximale, **PROFESSIONALISME** et **SERVICE** à nos clients habituels et potentiels. Ceci nous permettra de continuer à maintenir notre position de leader en anticipant les nécessités futures de nos marchés.

O **GRUPO ABRESSA**, dedicado ao fabrico e comercialização de todo o tipo de abrasivos para polimento de rochas ornamentais e pedra artificial, desde à 30 anos consolidado como líder mundial no seu sector, tem dado resposta a todo e qualquer problema posto pelos seus clientes.

Graças à sua continua expansão e crescimento, e com o objectivo de fornecer e dar o melhor serviço, o Grupo é formado pelas seguintes 4 empresas:

- **ABRASIVOS DE ESPAÑA, S.A.** (1970). Empresa matriz, radicada em Les Franqueses del Vallés (Barcelona). Superfície de 10.000 m². Fornece o mercado Espanhol e Europeu.
- **ABRESSA CERÁMICA, S.A.** (1989). Mollet del Vallés (Barcelona). Especializada em produtos cerâmicos.
- **ABRESSA CANADA, INC.** (1988). San Sebastián (Québec). Fornece o continente americano e o mercado da Índia.
- **ABRASIVOS DE PORTUGAL LDA.** (1992). Vila Nova de Cerveira (Portugal). 12.000 m². Fornece todo o resto dos mercados mundiais.

Um dos pontos fortes e premissa básica do **GRUPO ABRESSA**, é o Standard de **QUALIDADE**, o espírito de inovação e a melhoria contínua que impera no Grupo desde os seus inícios, aspecto esse que outorgou à nossa marca um grande prestígio em todo o mundo. Apostamos no constante investimento em Recursos Humanos e tecnológicos na área de investigação e desenvolvimento (I+D), assim como na contínua modernização das nossas equipas, instalações e métodos produtivos, com o objectivo de dar resposta à permanente evolução tecnológica que sofrem os nossos sectores, mediante a introdução de produtos especializados.

Outra das nossas preocupações é o cuidado com o meio ambiente, realizando um importante esforço económico e humano para conseguir reduzir quase a nível zero os resíduos e situarmo-nos entre as empresas mais consciencializadas para os temas ecológicos. Trabalhamos dia a dia para cumprirmos as normas de segurança laborais assim como a melhoria dos processos produtivos e organizacionais, obtendo as certificações **ISO 9001:2000 de Qualidade e ISO 14001:1996 do Meio Ambiente**.

O nosso objectivo principal é o de continuar no mercado fornecendo os nossos habituais e potenciais clientes, oferecendo a máxima **QUALIDADE, PROFISSIONALISMO E SERVIÇO** que nos permita manter a posição de liderança, resolvendo todas as necessidades que surjam em futuras situações de mercado.

Die **ABRESSA-GRUPPE** widmet sich der Herstellung und dem Vertrieb von Schleifkörpern jeglicher Art zum Polieren von Naturstein und Kunststein. Seit mehr als 30 Jahren ist die Gruppe weltweit führend auf diesem Gebiet und kann die besten Lösungen für jede Aufgabe, die unseren Kunden gestellt werden, präsentieren.

Dank ständiger Erweiterung und Vergrößerung mit dem Ziel, die beste Unterstützung anzubieten, umfasst die ABRESSA-Gruppe 4 Gesellschaften:

- **ABRASIVOS DE ESPAÑA, S.A.** (1970). Die Ursprungsgesellschaft mit Sitz in Barcelona (Les Franqueses de Vallés). Gesamtfläche von 10.000 m². Beliefert ganz Europa.
- **ABRESSA CERÁMICA, S.A.** (1989). Mollet del Vallés (Barcelona). Ist auf Keramikprodukte spezialisiert.
- **ABRESSA CANADA, INC.** (1988). Québec (San Sebastián). Beliefert hauptsächlich den amerikanischen Kontinent und den indischen Markt.
- **ABRASIVOS DE PORTUGAL LDA.** (1992). Portugal (Vila Nova de Cerveira), 12.000 m². Von hier aus wird der Rest der Welt beliefert.

Ein hoher **QUALITÄTSSTANDARD** sowie ständiges Bemühen um Innovation und Verbesserung sind Stärken der **ABRESSA-GRUPPE** und Merkmale unseres Ethos in dieser Gruppe seit Anfang an. Dies hat uns zu einer weltweit führenden Marke gemacht. Wir haben uns selbst dazu verpflichtet, unsere personellen und technischen Mittel für Forschung und Entwicklung (F & E) zu erhöhen und beständig unsere Einrichtungen, Ausstattungen und Produktionsmethoden zu modernisieren, um mit der permanenten technologischen Weiterentwicklung durch die Einführung spezieller Produkte Schritt zu halten.

Die Umwelt ist besonders wichtig für uns. Wir haben uns intensiv darum bemüht, den Abfall auf nahezu Null zurück zu führen. Wir erfüllen die gesetzlichen vorgegebenen Bedingungen und verbessern kontinuierlich unsere Produktions- und Logistikverfahren. Das Ergebnis dieses Engagements ist das **Qualitätszertifikat ISO 9001:2000 und das Umweltzertifikat ISO 14001:1996**.

Unsere Hauptaufgabe ist es, unsere Aktivitäten in diesem Geschäft für unsere vorhandenen und neuen Kunden mit besser **QUALITÄT, PROFESSIONALITÄT und SERVICE** fortzuführen, damit wir unsere Führungsposition behaupten und der Zukunft mit gestärkter Zuversicht entgegen sehen können.



The **ABRESSA GROUP** is dedicated to the manufacture and distribution of all kinds of abrasive bricks for polishing natural and artificial stone. For more than 30 years the group has been the world leader in its field and can offer the best solutions for any problem faced by our customers.

Thanks to continuous expansion and growth, dedicated to the aim of providing the best support, the ABRESSA group comprises 4 companies:

- **ABRASIVOS DE ESPAÑA, S.A.** (1970). The original company, located in Barcelona (Les Franqueses del Vallés). Total surface of 10.000 m², supplies to whole Europe.
- **ABRESSA CERÁMICA, S.A.** (1989). Mollet del Vallés (Barcelona). Specialized in products for ceramics.
- **ABRESSA CANADA, INC.** (1988). Québec (San Sebastián). Supplies mainly to the American continent and to the Indian market.
- **ABRASIVOS DE PORTUGAL LDA.** (1992). Portugal (Vila Nova de Cerveira), 12.000 m². Supplies to the rest of the world.

One of our strengths within the **ABRESSA GROUP** is the high **QUALITY** standard and our constant drive for innovation and improvement that has been a part of the ethos in the group from the very beginning. This has made us a leading brand all over the world. We have committed ourselves to increase our human and technological resources for research and development (R&D) and to continuously modernise our installations, equipment and production methods in order to adapt to the permanent technological evolution by the introduction of special products.

The environment is extremely important to us. We have put a great deal of effort into reducing waste to virtually zero and work well within legislated levels as well as making steady improvements to our production and logistical processes.

The result of this dedication is **ISO 9001:2000 certificate of Quality and ISO 14001:1996 certificate of Environment**.

Our main objective is to continue working in this business for our existing and new customers, offering the best **QUALITY, PROFESSIONALITY and SERVICE** so that we maintain our lead and can face the future with great confidence.

Le **GRUPE ABRESSA**, consacré à la fabrication et commercialisation de tout type de meules abrasives pour le polissage de pierres ornementales et artificielle, se consolide depuis plus de 30 ans comme leader mondial dans son secteur, répondant à n'importe quel problème soumis par nos clients.

Grâce à son expansion continue et développement, et avec l'objectif de fournir et donner le meilleur service, le Groupe est formé par les entreprises suivantes :

- **ABRASIVOS DE ESPAÑA, S.A.** (1970). Compagnie mère située à Les Franqueses del Valles (Barcelone). Surface de 10.000 m². Fournit le marché espagnol et européen.
- **ABRESSA CERÁMICA, S.A.** (1989). Mollet del Valles (Barcelone), spécialisée en produits céramiques.
- **ABRESSA CANADA, INC.** (1988). Saint Sébastien (Québec). Fournit le continent américain et le marché indien.
- **ABRASIVOS DE PORTUGAL LDA.** (1992). Vila Nova de Cerveira (Portugal). 12.000 m² de surface. Fournit le reste des marchés mondiaux.

Les points forts et piliers de base du **GRUPE ABRESSA**, sont le standard de **QUALITÉ** et l'esprit d'innovation et d'amélioration continue qui dirigent le Groupe depuis ses débuts. Ces aspects ont valu à notre marque un grand prestige à travers le monde. Nous misons sur l'investissement constant en ressources technologiques et humaines dans le secteur de la recherche et développement (R&D) et la continue modernisation de nos équipements, installations et méthodes de production afin de répondre à la permanente évolution technologique qui existe dans nos secteurs moyennant l'introduction de produits spécialisés.

Une autre de nos préoccupations est le souci de l'environnement. Nous réalisons un important effort économique et humain pour réduire presque à zéro les résidus et nous situer dans les entreprises les plus conscientisées au point de vue écologique. Nous travaillons quotidiennement à l'exécution des normes des risques au travail ainsi qu'à l'amélioration des procédés de production et d'organisation. Nous avons obtenu les certifications **ISO 9001 :2000 de Qualité et ISO 14001 :1996 d'Environnement**.

Notre objectif principal est celui de continuer d'offrir **QUALITÉ** maximale, **PROFESSIONALISME** et **SERVICE** à nos clients habituels et potentiels. Ceci nous permettra de continuer à maintenir notre position de leader en anticipant les nécessités futures de nos marchés.

O **GRUPO ABRESSA**, dedicado ao fabrico e comercialização de todo o tipo de abrasivos para polimento de rochas ornamentais e pedra artificial, desde à 30 anos consolidado como líder mundial no seu sector, tem dado resposta a todo e qualquer problema posto pelos seus clientes.

Grças à sua continua expansão e crescimento, e com o objectivo de fornecer e dar o melhor serviço, o Grupo é formado pelas seguintes 4 empresas:

- **ABRASIVOS DE ESPAÑA, S.A.** (1970). Empresa matriz, radicada em Les Franqueses del Vallés (Barcelona). Superfície de 10.000 m². Fornece o mercado Espanhol e Europeu.
- **ABRESSA CERÁMICA, S.A.** (1989). Mollet del Vallés (Barcelona). Especializada em produtos cerâmicos.
- **ABRESSA CANADA, INC.** (1988). San Sebastián (Québec). Fornece o continente americano e o mercado da Índia.
- **ABRASIVOS DE PORTUGAL LDA.** (1992). Vila Nova de Cerveira (Portugal). 12.000 m². Fornece todo o resto dos mercados mundiais.

Um dos pontos fortes e premissa básica do **GRUPO ABRESSA**, é o Standard de **QUALIDADE**, o espírito de inovação e a melhoria continua que impera no Grupo desde os seus inícios, aspecto esse que outorgou à nossa marca um grande prestígio em todo o mundo. Apostamos no constante investimento em Recursos Humanos e tecnológicos na área de investigação e desenvolvimento (I+D), assim como na continua modernização das nossas equipas, instalações e métodos produtivos, com o objectivo de dar resposta à permanente evolução tecnológica que sofrem os nossos sectores, mediante a introdução de produtos especializados.

Outra das nossas preocupações é o cuidado com o meio ambiente, realizando um importante esforço económico e humano para conseguir reduzir quase a nível zero os resíduos e situarmo-nos entre as empresas mais consciencializadas para os temas ecológicos. Trabalhamos dia a dia para cumprirmos as normas de segurança laborais assim como a melhoria dos processos produtivos e organizacionais, obtendo as certificações **ISO 9001:2000 de Qualidade e ISO 14001:1996 do Meio Ambiente**.

O nosso objectivo principal é o de continuar no mercado fornecendo os nossos habituais e potenciais clientes, oferecendo a máxima **QUALIDADE, PROFISSIONALISMO E SERVIÇO** que nos permita manter a posição de liderança, resolvendo todas as necessidades que surjam em futuras situações de mercado.

Die **ABRESSA-GRUPPE** widmet sich der Herstellung und dem Vertrieb von Schleifkörpern jeglicher Art zum Polieren von Naturstein und Kunststein. Seit mehr als 30 Jahren ist die Gruppe weltweit führend auf diesem Gebiet und kann die besten Lösungen für jede Aufgabe, die unseren Kunden gestellt werden, präsentieren.

Dank ständiger Erweiterung und Vergrößerung mit dem Ziel, die beste Unterstützung anzubieten, umfasst die ABRESSA-Gruppe 4 Gesellschaften:

- **ABRASIVOS DE ESPAÑA, S.A.** (1970). Die Ursprungsgesellschaft mit Sitz in Barcelona (Les Franqueses de Vallés). Gesamtfläche von 10.000 m². Beliefert ganz Europa.
- **ABRESSA CERÁMICA, S.A.** (1989). Mollet del Vallés (Barcelona). Ist auf Keramikprodukte spezialisiert.
- **ABRESSA CANADA, INC.** (1988). Québec (San Sebastián). Beliefert hauptsächlich den amerikanischen Kontinent und den indischen Markt.
- **ABRASIVOS DE PORTUGAL LDA.** (1992). Portugal (Vila Nova de Cerveira), 12.000 m². Von hier aus wird der Rest der Welt beliefert.

Ein hoher **QUALITÄTSSTANDARD** sowie ständiges Bemühen um Innovation und Verbesserung sind Stärken der **ABRESSA-GRUPPE** und Merkmale unseres Ethos in dieser Gruppe seit Anfang an. Dies hat uns zu einer weltweit führenden Marke gemacht. Wir haben uns selbst dazu verpflichtet, unsere personellen und technischen Mittel für Forschung und Entwicklung (F & E) zu erhöhen und beständig unsere Einrichtungen, Ausstattungen und Produktionsmethoden zu modernisieren, um mit der permanenten technologischen Weiterentwicklung durch die Einführung spezieller Produkte Schritt zu halten.

Die Umwelt ist besonders wichtig für uns. Wir haben uns intensiv darum bemüht, den Abfall auf nahezu Null zurück zu führen. Wir erfüllen die gesetzlichen vorgegebenen Bedingungen und verbessern kontinuierlich unsere Produktions- und Logistikverfahren. Das Ergebnis dieses Engagements ist das **Qualitätszertifikat ISO 9001:2000 und das Umweltzertifikat ISO 14001:1996**.

Unsere Hauptaufgabe ist es, unsere Aktivitäten in diesem Geschäft für unsere vorhandenen und neuen Kunden mit bester **QUALITÄT, PROFESSIONALITÄT und SERVICE** fortzuführen, damit wir unsere Führungsposition behaupten und der Zukunft mit gestärkter Zuversicht entgegen sehen können.

LIGANTES/ BOND MATERIAL	GRANOS/ GRITS	APLICACIONES/ APPLICATIONS	MATERIALES/ MATERIALS
VELOX 	16-1800	Desbaste/Grinding Pulido/Polishing	Granito/ Granite Mármol/ Marble Caliza/ Limestone Terrazo/ Terrazzo Gres/ Ceramic Arenisca/ Sandstone Aglomerado de cuarzo/ Quartz agglomerate Piedra artificial/ Artificial stone Pizarra/ Slate
POROX 	400-1800	Pulido/ Polishing	Mármol/ Marble Terrazo/ Terrazzo Piedra artificial/ Artificial stone
SYNTER 	Sin grano/ Without grit	Abrillantado/ Shine	Mármol/ Marble Caliza/ Limestone Terrazo/ Terrazzo
BRILLO 	Sin grano/ Without grit	Abrillantado/ Shine	Granito/ Granite Gres/ Ceramic Piedra artificial/ Artificial stone
GLOSSEX 	Sin grano/ Without grit	Abrillantado/ Shine	Granito/ Granite
RESIPOX 	30-800	Desbaste/Grinding Pulido/Polishing	Granito/ Granite Mármol/ Marble Caliza/ Limestone Terrazo/ Terrazzo Gres/ Ceramic Arenisca/ Sandstone Aglomerado de cuarzo/ Quartz agglomerate Piedra artificial/ Artificial stone Pizarra/ Slate
SATINEX 	36-500	Efecto de envejecido/ Antiquing effect	Granito/ Granite Mármol/ Marble Caliza/ Limestone Terrazo/ Terrazzo Gres/ Ceramic Arenisca/ Sandstone Aglomerado de cuarzo/ Quartz agglomerate Piedra artificial/ Artificial stone Pizarra/ Slate
POMEX 	Sin grano/ Without grit	Limpieza de rayas y sombras en apomazado/ Cleaning of scratches and shadows after smoothening	Mármol/ Marble Caliza/ Limestone Arenisca/ Sandstone Aglomerado de cuarzo/ Quartz agglomerate Pizarra/ Slate
LIMPIADOR 	Sin grano/ Without grit	Eliminación de restos de agente abrillantador/ Elimination of rests of the shining product	Mármol/ Marble Caliza/ Limestone

VENTAJAS DE LOS PRODUCTOS ABRESSA

ESTABILIDAD

los abrasivos ABRESSA son completamente estables en el tiempo con la ventaja añadida de que no endurecen tras largos periodos de almacenaje.

RELACIÓN COSTE/PRECIO

Los abrasivos ABRESSA se adaptan a cualquier máquina de pulido - antiguas y modernas - con un óptimo coste por m².

DIVERSIDAD

Nuestra gama de abrasivos puede ser suministrada en cualquier tipo de formato y en seis tipos de dureza en función de las necesidades de la máquina y del material a pulir.

CALIDAD ÓPTIMA

Se consigue una calidad óptima de pulido a presiones bajas y a alta velocidad de cinta.

LÍDER EN SERVICIO

Asesoramiento técnico, compromiso en plazo de entrega y en calidad (ISO 9001:2000).

RESPECTO CON EL MEDIO AMBIENTE

Gestión de residuos de acuerdo con la normativa ISO 14001:1996

I+D

La continua mejora e innovación permite desarrollar los mejores productos.

MAIN ADVANTAGES OF ABRESSA PRODUCTS

LONG LIFE STABILITY

ABRESSA abrasives do not change with time. Primarily this means they do not get harder after long periods of storage.

COST/PRICE RATIO

ABRESSA abrasives are compatible with all kind of polishing machines: both modern and older ones and guarantee polishing at an optimal cost.

VARIETY

Our range of abrasives can be supplied in many shapes and in 6 different hardnesses as required by the machine and the material being polished.

OPTIMAL QUALITY

We achieve the optimal quality at low working pressures and at high band speeds.

LEADER IN SERVICE

We provide technical support and advice, a commitment to delivery times and guaranteed quality (ISO 9001:2000).

ENVIRONMENT

Waste reduction and treatment according to ISO 14001:1996.

R&D

The continuous search for improvement and innovation allows us to develop the best products.

LIGANTES/ BOND MATERIAL	GRANOS/ GRITS	APLICACIONES/ APPLICATIONS	MATERIALES/ MATERIALS
VELOX 	16-1800	Desbaste/Grinding Pulido/Polishing	Granito/ Granite Mármol/ Marble Caliza/ Limestone Terrazo/ Terrazzo Gres/ Ceramic Arenisca/ Sandstone Aglomerado de cuarzo/ Quartz agglomerate Piedra artificial/ Artificial stone Pizarra/ Slate
POROX 	400-1800	Pulido/Polishing	Mármol/ Marble Terrazo/ Terrazzo Piedra artificial/ Artificial stone
SYNTER 	Sin grano/ Without grit	Abrillantado/ Shine	Mármol/ Marble Caliza/ Limestone Terrazo/ Terrazzo
BRILLO 	Sin grano/ Without grit	Abrillantado/ Shine	Granito/ Granite Gres/ Ceramic Piedra artificial/ Artificial stone
GLOSSEX 	Sin grano/ Without grit	Abrillantado/ Shine	Granito/ Granite
RESIPOX 	30-800	Desbaste/Grinding Pulido/Polishing	Granito/ Granite Mármol/ Marble Caliza/ Limestone Terrazo/ Terrazzo Gres/ Ceramic Arenisca/ Sandstone Aglomerado de cuarzo/ Quartz agglomerate Piedra artificial/ Artificial stone Pizarra/ Slate
SATINEX 	36-500	Efecto de envejecido/ Antiquing effect	Granito/ Granite Mármol/ Marble Caliza/ Limestone Terrazo/ Terrazzo Gres/ Ceramic Arenisca/ Sandstone Aglomerado de cuarzo/ Quartz agglomerate Piedra artificial/ Artificial stone Pizarra/ Slate
POMEX 	Sin grano/ Without grit	Limpieza de rayas y sombras en apomazado/ Cleaning of scratches and shadows after smoothening	Mármol/ Marble Caliza/ Limestone Arenisca/ Sandstone Aglomerado de cuarzo/ Quartz agglomerate Pizarra/ Slate
LIMPIADOR 	Sin grano/ Without grit	Eliminación de restos de agente abrillantador/ Elimination of rests of the shining product	Mármol/ Marble Caliza/ Limestone

VENTAJAS DE LOS PRODUCTOS ABRESSA

ESTABILIDAD

los abrasivos ABRESSA son completamente estables en el tiempo con la ventaja añadida de que no endurecen tras largos periodos de almacenaje.

RELACIÓN COSTE/PRECIO

Los abrasivos ABRESSA se adaptan a cualquier máquina de pulido - antiguas y modernas - con un óptimo coste por m².

DIVERSIDAD

Nuestra gama de abrasivos puede ser suministrada en cualquier tipo de formato y en seis tipos de dureza en función de las necesidades de la máquina y del material a pulir.

CALIDAD ÓPTIMA

Se consigue una calidad óptima de pulido a presiones bajas y a alta velocidad de cinta.

LÍDER EN SERVICIO

Asesoramiento técnico, compromiso en plazo de entrega y en calidad (ISO 9001:2000).

RESPECTO CON EL MEDIO AMBIENTE

Gestión de residuos de acuerdo con la normativa ISO 14001:1996

I+D

La continua mejora e innovación permite desarrollar los mejores productos.

MAIN ADVANTAGES OF ABRESSA PRODUCTS

LONG LIFE STABILITY

ABRESSA abrasives do not change with time. Primarily this means they do not get harder after long periods of storage.

COST/PRICE RATIO

ABRESSA abrasives are compatible with all kind of polishing machines: both modern and older ones and guarantee polishing at an optimal cost.

VARIETY

Our range of abrasives can be supplied in many shapes and in 6 different hardnesses as required by the machine and the material being polished.

OPTIMAL QUALITY

We achieve the optimal quality at low working pressures and at high band speeds.

LEADER IN SERVICE

We provide technical support and advice, a commitment to delivery times and guaranteed quality (ISO 9001:2000).

ENVIRONMENT

Waste reduction and treatment according to ISO 14001:1996.

R&D

The continuous search for improvement and innovation allows us to develop the best products.



V-140

CODE 04E

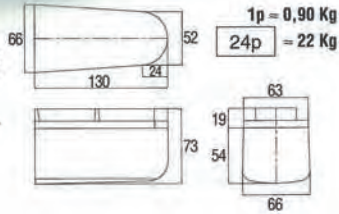

LIGANTES DISPONIBLES:



S-140

CODE 05S

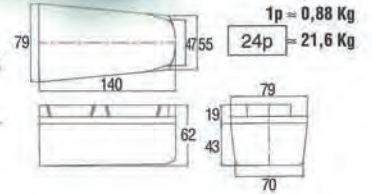

LIGANTES DISPONIBLES:



6



S-140 POMEX

CODE 06M

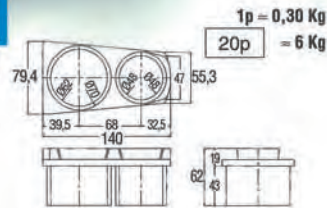

LIGANTES DISPONIBLES:



W-140

CODE 04W

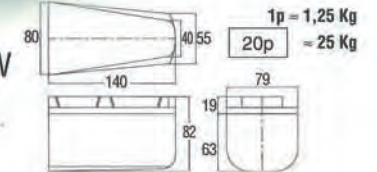

LIGANTES DISPONIBLES:



G-150

CODE 04X

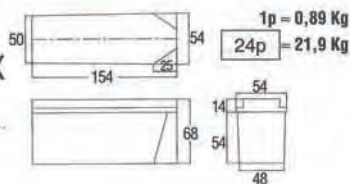

LIGANTES DISPONIBLES:



U-170

CODE 06T

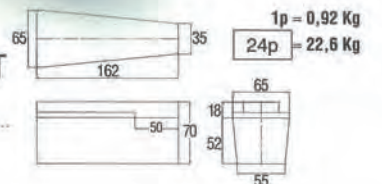

LIGANTES DISPONIBLES:



Tabla de equivalencias. - Grit Size equivalences

	000	00	0	45	1	A	C	2	F	K	3	H	N	4	5	6	7	8	10	12	15	18
FEPA	16	24	30	46	60	80	100	120	150	180	220	240	280	400	500	600	700	800	1000	1200	1500	1800



V-140

CODE 04E

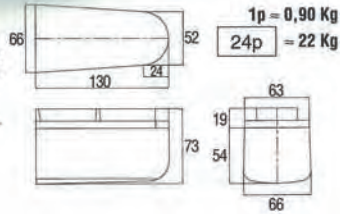

LIGANTES DISPONIBLES:



S-140

CODE 05S

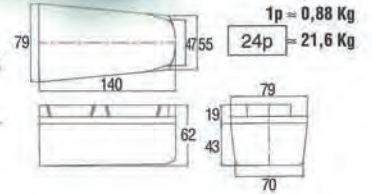

LIGANTES DISPONIBLES:



6



S-140 POMEX

CODE 06M

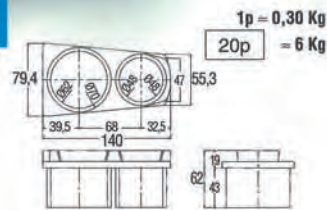

LIGANTES DISPONIBLES:



W-140

CODE 04W

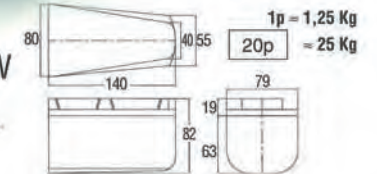

LIGANTES DISPONIBLES:



G-150

CODE 04X

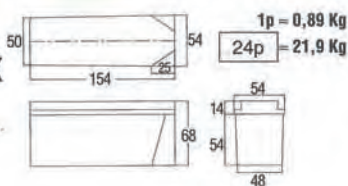

LIGANTES DISPONIBLES:



U-170

CODE 06T

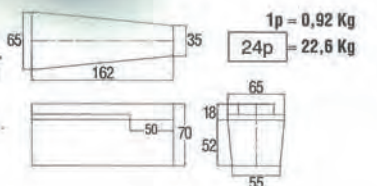

LIGANTES DISPONIBLES:



Tabla de equivalencias. - Grit Size equivalences

	000	00	0	45	1	A	C	2	F	K	3	H	N	4	5	6	7	8	10	12	15	18
FEPA	16	24	30	46	60	80	100	120	150	180	220	240	280	400	500	600	700	800	1000	1200	1500	1800



S-200

CODE 09Q

LIGANTES DISPONIBLES:

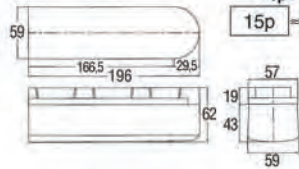

1p = 1,14 Kg
15p = 17,5 Kg



V-200

CODE 04K

LIGANTES DISPONIBLES:

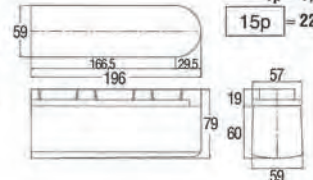

1p = 1,48 Kg
15p = 22,6 Kg

8



F-260

CODE 04J

LIGANTES DISPONIBLES:

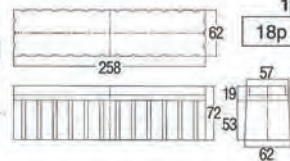

1p = 1,91 Kg
18p = 34,9 Kg



100 BLOC

CODE 01A

LIGANTES DISPONIBLES:

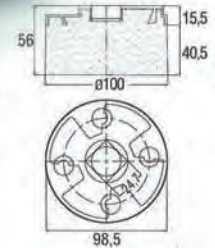

1p = 0,74 Kg
32p = 24,2 Kg



125x50 T BLOC

CODE 02M

LIGANTES DISPONIBLES:

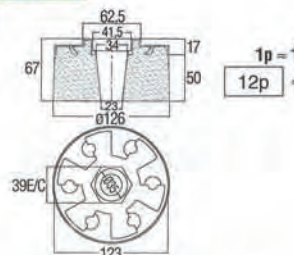

1p = 1,38 Kg
12p = 17 Kg



125x50 BLOC

CODE 02L

LIGANTES DISPONIBLES:

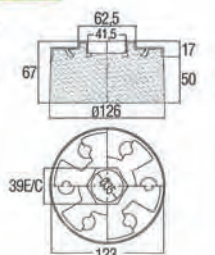

1p = 1,43 Kg
12p = 17,6 Kg

Tabla de equivalencias. - Grit Size equivalences

	000	00	0	45	1	A	C	2	F	K	3	H	N	4	5	6	7	8	10	12	15	18
FEPA	16	24	30	46	60	80	100	120	150	180	220	240	280	400	500	600	700	800	1000	1200	1500	1800



S-200

CODE 09Q

LIGANTES DISPONIBLES:

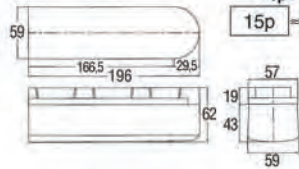

1p = 1,14 Kg
15p = 17,5 Kg



V-200

CODE 04K

LIGANTES DISPONIBLES:

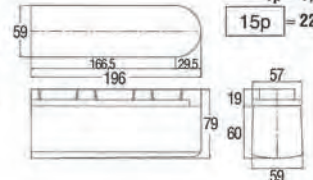

1p = 1,48 Kg
15p = 22,6 Kg

8



F-260

CODE 04J

LIGANTES DISPONIBLES:

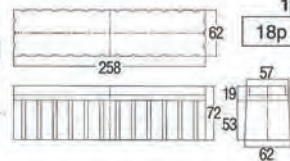

1p = 1,91 Kg
18p = 34,9 Kg



100 BLOC

CODE 01A

LIGANTES DISPONIBLES:

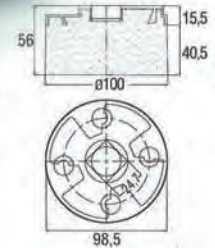

1p = 0,74 Kg
32p = 24,2 Kg



125x50 T BLOC

CODE 02M

LIGANTES DISPONIBLES:

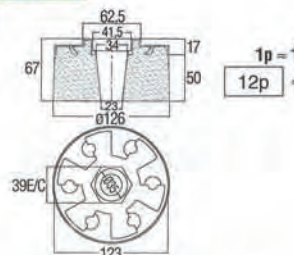

1p = 1,38 Kg
12p = 17 Kg



125x50 BLOC

CODE 02L

LIGANTES DISPONIBLES:

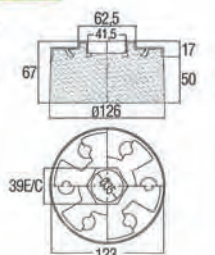

1p = 1,43 Kg
12p = 17,6 Kg

Tabla de equivalencias. - Grit Size equivalences

	000	00	0	45	1	A	C	2	F	K	3	H	N	4	5	6	7	8	10	12	15	18
FEPA	16	24	30	46	60	80	100	120	150	180	220	240	280	400	500	600	700	800	1000	1200	1500	1800



100 FRM

CODE 01P

LIGANTES DISPONIBLES:

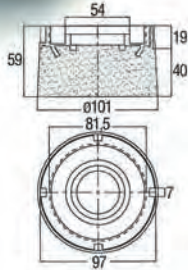

1p = 0,64 Kg
32p = 21 Kg



120x50 T FRM

CODE 02W

LIGANTES DISPONIBLES:

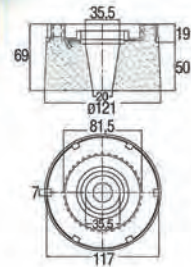

1p = 1,15 Kg
16p = 18,8 Kg

10



120x50 FRM

CODE 02Q

LIGANTES DISPONIBLES:

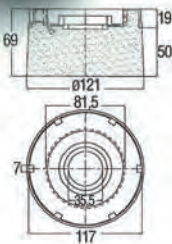

1p = 1,14 Kg
16p = 18,7 Kg



120 T FRM

CODE 02V

LIGANTES DISPONIBLES:

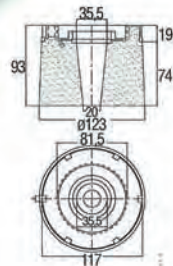

1p = 1,69 Kg
12p = 20,7 Kg



120 FRM

CODE 02P

LIGANTES DISPONIBLES:

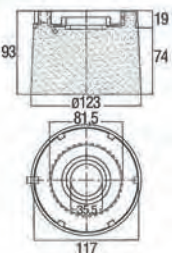

1p = 1,79 Kg
12p = 21,9 Kg

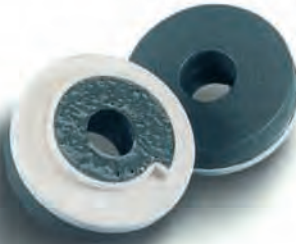

100x20 SH

CODE 01G

LIGANTES DISPONIBLES:

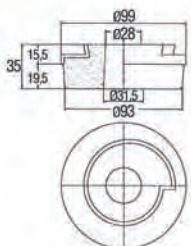

1p = 0,37 Kg
16p = 6,4 Kg

Tabla de equivalencias. - Grit Size equivalences

	000	00	0	45	1	A	C	2	F	K	3	H	N	4	5	6	7	8	10	12	15	18
FEPA	16	24	30	46	60	80	100	120	150	180	220	240	280	400	500	600	700	800	1000	1200	1500	1800



100 FRM

CODE 01P

LIGANTES DISPONIBLES:

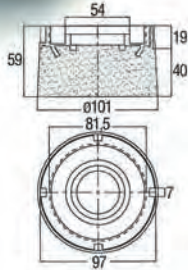

1p = 0,64 Kg
32p = 21 Kg



120x50 T FRM

CODE 02W

LIGANTES DISPONIBLES:

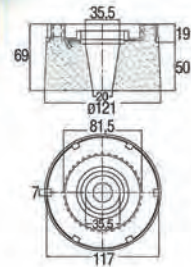

1p = 1,15 Kg
16p = 18,8 Kg

10



120x50 FRM

CODE 02Q

LIGANTES DISPONIBLES:

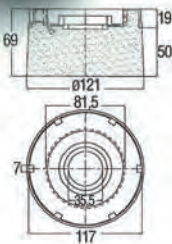

1p = 1,14 Kg
16p = 18,7 Kg



120 T FRM

CODE 02V

LIGANTES DISPONIBLES:

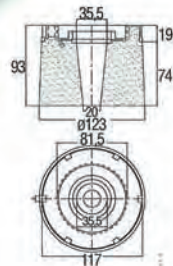

1p = 1,69 Kg
12p = 20,7 Kg



120 FRM

CODE 02P

LIGANTES DISPONIBLES:

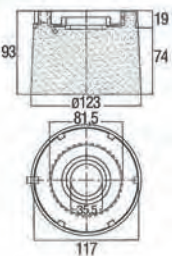

1p = 1,79 Kg
12p = 21,9 Kg

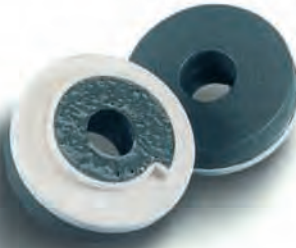

100x20 SH

CODE 01G

LIGANTES DISPONIBLES:

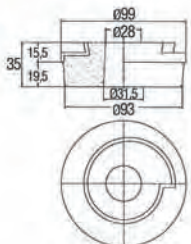

1p = 0,37 Kg
16p = 6,4 Kg

Tabla de equivalencias. - Grit Size equivalences

	000	00	0	45	1	A	C	2	F	K	3	H	N	4	5	6	7	8	10	12	15	18
FEPA	16	24	30	46	60	80	100	120	150	180	220	240	280	400	500	600	700	800	1000	1200	1500	1800



130x20 VPSH

CODE 09D

1p = 0,73 Kg
16p = 12,2 Kg

LIGANTES DISPONIBLES:

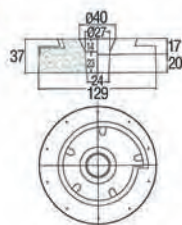
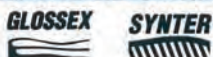

130x30 ESH

CODE 07V

1p = 0,68 Kg
16p = 11,4 Kg

LIGANTES DISPONIBLES:

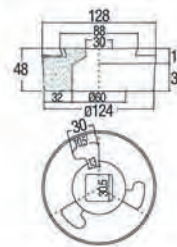

12



130x30 SH

CODE 02G

1p = 0,79 Kg
16p = 13,1 Kg

LIGANTES DISPONIBLES:

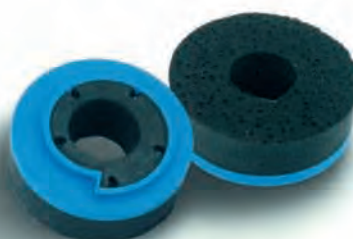
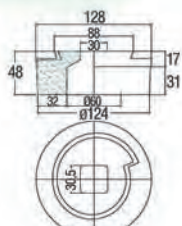

130x30 VSH

CODE 03T

1p = 0,90 Kg
16p = 14,9 Kg

LIGANTES DISPONIBLES:

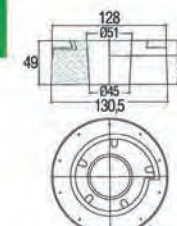

130x30 VSH-I

CODE 02I

1p = 0,80 Kg
16p = 13,3 Kg

LIGANTES DISPONIBLES:

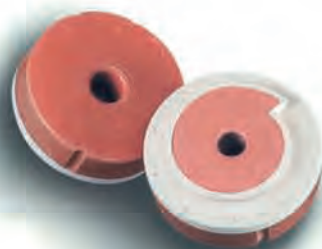
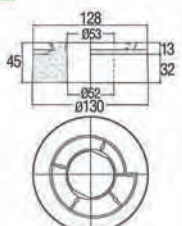

130x30 PSH

CODE 02B

1p = 0,87 Kg
16p = 14,4 Kg

LIGANTES DISPONIBLES:



Tabla de equivalencias. - Grit Size equivalences

FEPA	000	00	0	45	1	A	C	2	F	K	3	H	N	4	5	6	7	8	10	12	15	18
	16	24	30	46	60	80	100	120	150	180	220	240	280	400	500	600	700	800	1000	1200	1500	1800

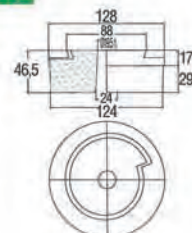

130x20 VPSH

CODE 09D

1p = 0,73 Kg
16p = 12,2 Kg

LIGANTES DISPONIBLES:

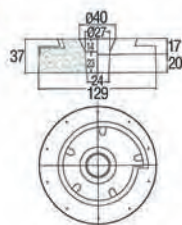
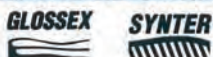

130x30 ESH

CODE 07V

1p = 0,68 Kg
16p = 11,4 Kg

LIGANTES DISPONIBLES:

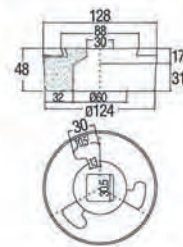

12



130x30 SH

CODE 02G

1p = 0,79 Kg
16p = 13,1 Kg

LIGANTES DISPONIBLES:

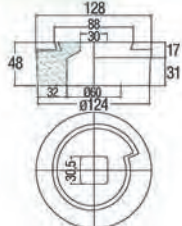

130x30 VSH

CODE 03T

1p = 0,90 Kg
16p = 14,9 Kg

LIGANTES DISPONIBLES:

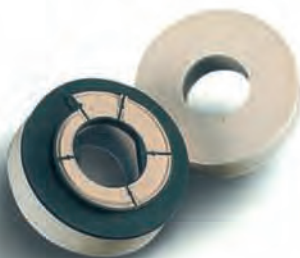
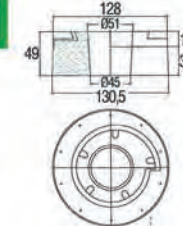

130x30 VSH-I

CODE 02I

1p = 0,80 Kg
16p = 13,3 Kg

LIGANTES DISPONIBLES:

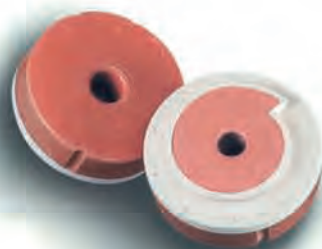
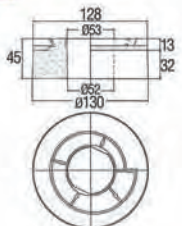

130x30 PSH

CODE 02B

1p = 0,87 Kg
16p = 14,4 Kg

LIGANTES DISPONIBLES:



Tabla de equivalencias. - Grit Size equivalences

	000	00	0	45	1	A	C	2	F	K	3	H	N	4	5	6	7	8	10	12	15	18
FEPA	16	24	30	46	60	80	100	120	150	180	220	240	280	400	500	600	700	800	1000	1200	1500	1800

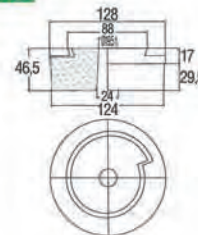

P-130

CODE 76P

1p = 0,9 Kg
30p = 27 Kg

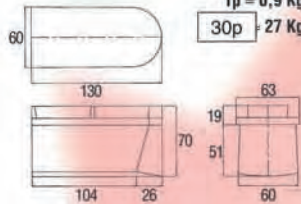

AVAILABLE BOND MATERIALS:



V-140

CODE 74E

1p = 0,9 Kg
30p = 27 Kg

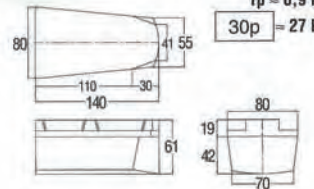

AVAILABLE BOND MATERIALS:



GM-140

CODE 74Y

1p = 0,9 Kg
30p = 27 Kg

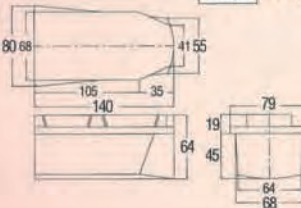

AVAILABLE BOND MATERIALS:



C-140

CODE 74T

1p = 1 Kg
24p = 25 Kg

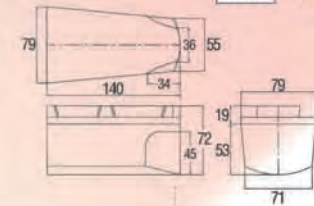

AVAILABLE BOND MATERIALS:



T-140

CODE 74V

1p = 1,4 Kg
20p = 29 Kg

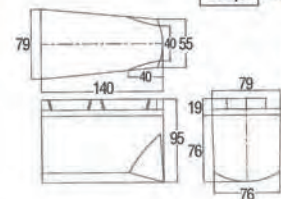

AVAILABLE BOND MATERIALS:



C-150

CODE 75T

1p = 1,3 Kg
20p = 26 Kg

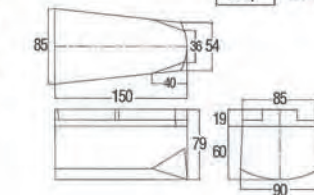

AVAILABLE BOND MATERIALS:



Grit Size equivalences - Table d'équivalences de grains - Tabla de equivalencias

	000	00	0	45	1	A	C	2	F	K	3	H	N	4	5	6	7	8	10	12	15	18
FEPA	16	24	30	46	60	80	100	120	150	180	220	240	280	400	500	600	700	800	1000	1200	1500	1800



P-130

CODE 76P

1p = 0,9 Kg
30p = 27 Kg

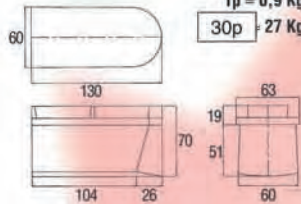

AVAILABLE BOND MATERIALS:



V-140

CODE 74E

1p = 0,9 Kg
30p = 27 Kg

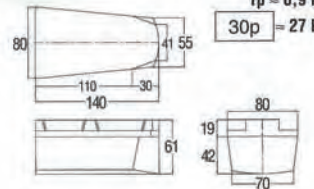

AVAILABLE BOND MATERIALS:



GM-140

CODE 74Y

1p = 0,9 Kg
30p = 27 Kg

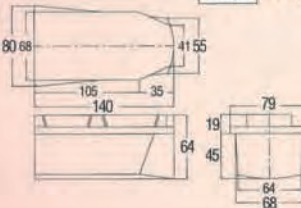

AVAILABLE BOND MATERIALS:



C-140

CODE 74T

1p = 1 Kg
24p = 25 Kg

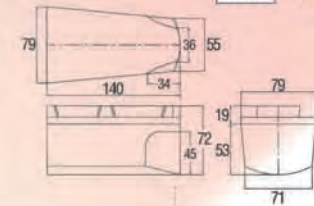

AVAILABLE BOND MATERIALS:



T-140

CODE 74V

1p = 1,4 Kg
20p = 29 Kg

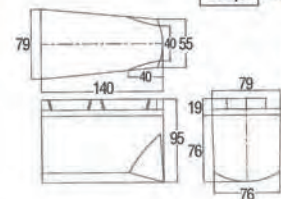

AVAILABLE BOND MATERIALS:



C-150

CODE 75T

1p = 1,3 Kg
20p = 26 Kg

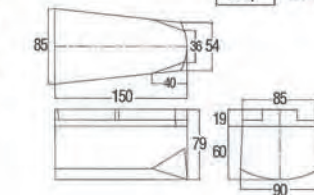

AVAILABLE BOND MATERIALS:



Grit Size equivalences - Table d'équivalences de grains - Tabla de equivalencias

	000	00	0	45	1	A	C	2	F	K	3	H	N	4	5	6	7	8	10	12	15	18
FEPA	16	24	30	46	60	80	100	120	150	180	220	240	280	400	500	600	700	800	1000	1200	1500	1800



150x40 ESH

CODE 73H

1p = 1,1 Kg
24p = 27 Kg

AVAILABLE BOND MATERIALS:

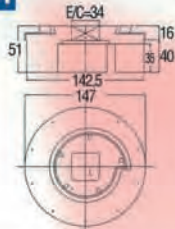

150x40 ESH-I

CODE 73M

1p = 1,1 Kg
24p = 27 Kg

AVAILABLE BOND MATERIALS:

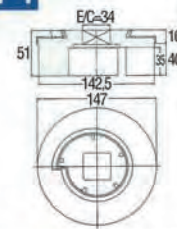

150x28 LSH

CODE 73D

1p = 1,1 Kg
24p = 27 Kg

AVAILABLE BOND MATERIALS:

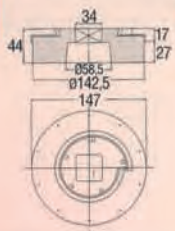

150x28 LSH-I

CODE 73N

1p = 1,1 Kg
24p = 27 Kg

AVAILABLE BOND MATERIALS:

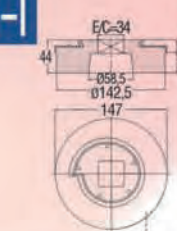

150x28 PSH

CODE 73I

1p = 1,3 Kg
24p = 31 Kg

AVAILABLE BOND MATERIALS:

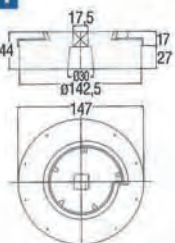

150x28 PSH-I

CODE 73O

1p = 1,3 Kg
24p = 31 Kg

AVAILABLE BOND MATERIALS:

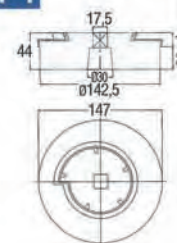

Grit Size equivalences - Table d'équivalences de grains - Tabla de equivalencias

	000	00	0	45	1	A	C	2	F	K	3	H	N	4	5	6	7	8	10	12	15	18
FEPA	16	24	30	46	60	80	100	120	150	180	220	240	280	400	500	600	700	800	1000	1200	1500	1800



150x40 ESH

CODE 73H

1p = 1,1 Kg
24p = 27 Kg

AVAILABLE BOND MATERIALS:

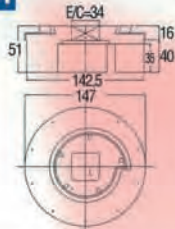

150x40 ESH-I

CODE 73M

1p = 1,1 Kg
24p = 27 Kg

AVAILABLE BOND MATERIALS:

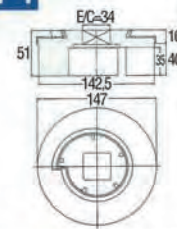

150x28 LSH

CODE 73D

1p = 1,1 Kg
24p = 27 Kg

AVAILABLE BOND MATERIALS:

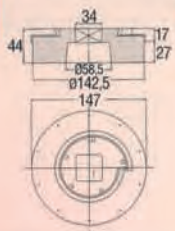

150x28 LSH-I

CODE 73N

1p = 1,1 Kg
24p = 27 Kg

AVAILABLE BOND MATERIALS:

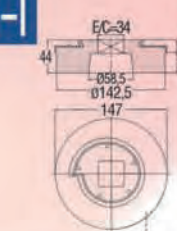

150x28 PSH

CODE 73I

1p = 1,3 Kg
24p = 31 Kg

AVAILABLE BOND MATERIALS:

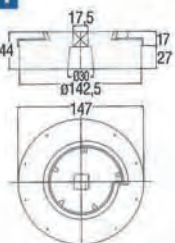

150x28 PSH-I

CODE 73O

1p = 1,3 Kg
24p = 31 Kg

AVAILABLE BOND MATERIALS:

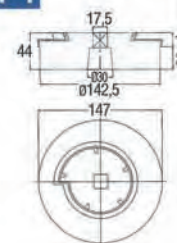

Grit Size equivalences - Table d'équivalences de grains - Tabla de equivalencias

	000	00	0	45	1	A	C	2	F	K	3	H	N	4	5	6	7	8	10	12	15	18
FEPA	16	24	30	46	60	80	100	120	150	180	220	240	280	400	500	600	700	800	1000	1200	1500	1800



150x40 PSH

CODE 03Z

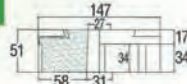

1p = 1,30 Kg
12p = 15,9 Kg

LIGANTES DISPONIBLES:



90x35 M14

CODE 01M

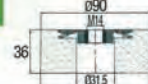

1p = 0,39 Kg
18p = 7,2 Kg

LIGANTES DISPONIBLES:



14



100x35 M14

CODE 01R



1p = 0,56 Kg
16p = 9,3 Kg

LIGANTES DISPONIBLES:



100/125 M14

CODE 01S



1p = 0,58 Kg
16p = 9,6 Kg

LIGANTES DISPONIBLES:



100/110 FERRO

CODE 01T

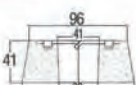

1p = 0,61 Kg
24p = 15 Kg

LIGANTES DISPONIBLES:



200x50

CODE 03C

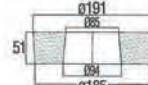

1p = 2,05 Kg
8p = 16,9 Kg

LIGANTES DISPONIBLES:



Tabla de equivalencias. - Grit Size equivalences

	000	00	0	45	1	A	C	2	F	K	3	H	N	4	5	6	7	8	10	12	15	18
FEPA	16	24	30	46	60	80	100	120	150	180	220	240	280	400	500	600	700	800	1000	1200	1500	1800



150x40 PSH

CODE 03Z

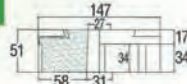

1p = 1,30 Kg
12p = 15,9 Kg

LIGANTES DISPONIBLES:



90x35 M14

CODE 01M

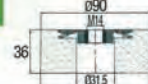

1p = 0,39 Kg
18p = 7,2 Kg

LIGANTES DISPONIBLES:



14



100x35 M14

CODE 01R

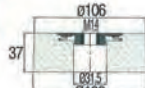

1p = 0,56 Kg
16p = 9,3 Kg

LIGANTES DISPONIBLES:



100/125 M14

CODE 01S



1p = 0,58 Kg
16p = 9,6 Kg

LIGANTES DISPONIBLES:



100/110 FERRO

CODE 01T

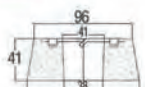

1p = 0,61 Kg
24p = 15 Kg

LIGANTES DISPONIBLES:



200x50

CODE 03C

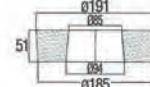

1p = 2,05 Kg
8p = 16,9 Kg

LIGANTES DISPONIBLES:



Tabla de equivalencias. - Grit Size equivalences

	000	00	0	45	1	A	C	2	F	K	3	H	N	4	5	6	7	8	10	12	15	18
FEPA	16	24	30	46	60	80	100	120	150	180	220	240	280	400	500	600	700	800	1000	1200	1500	1800



FRANKFURT

CODE 05A

1p = 0,62 Kg
36p = 22,8 Kg

LIGANTES DISPONIBLES:

- VELOX**
- GLOSSEX**
- POROX**
- LIMPIADOR**
- RESIPOX**
- TTTTTT**

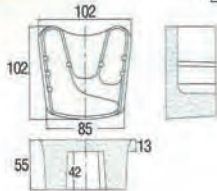

FRANKFURT MAC

CODE 05G

1p = 0,72 Kg
36p = 26,4 Kg

LIGANTES DISPONIBLES:

- VELOX**
- GLOSSEX**
- POROX**
- LIMPIADOR**
- RESIPOX**
- TTTTTT**

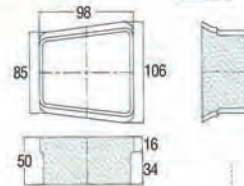

16



FRANKFURT SYNTER

CODE 05F

1p = 0,61 Kg
36p = 22,5 Kg

LIGANTES DISPONIBLES:

- SYNTER**

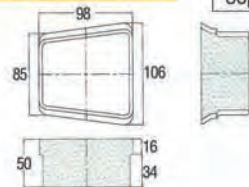

FRANKFURT PLUS

CODE 05P

1p = 0,82 Kg
24p = 20,2 Kg

LIGANTES DISPONIBLES:

- VELOX**
- GLOSSEX**
- RESIPOX**
- TTTTTT**
- POROX**

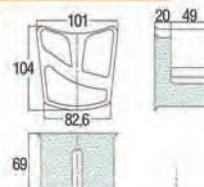

BIG FRANKFURT

CODE 05D

1p = 0,84 Kg
24p = 20,6 Kg

LIGANTES DISPONIBLES:

- VELOX**
- GLOSSEX**
- RESIPOX**
- POROX**

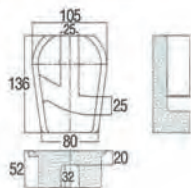

FRANKFURT POMEX

CODE 05E

1p = 0,15 Kg
36p = 6 Kg

LIGANTES DISPONIBLES:

- POMEX**



Tabla de equivalencias. - Grit Size equivalences

	000	00	0	45	1	A	C	2	F	K	3	H	N	4	5	6	7	8	10	12	15	18
FEPA	16	24	30	46	60	80	100	120	150	180	220	240	280	400	500	600	700	800	1000	1200	1500	1800

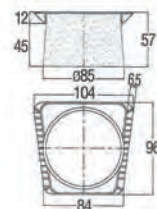

FRANKFURT

CODE 05A

1p = 0,62 Kg
36p = 22,8 Kg

LIGANTES DISPONIBLES:

- VELOX**
- GLOSSEX**
- POROX**
- LIMPIADOR**
- RESIPOX**
- TTTTTT**

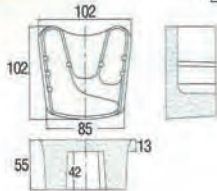

FRANKFURT MAC

CODE 05G

1p = 0,72 Kg
36p = 26,4 Kg

LIGANTES DISPONIBLES:

- VELOX**
- GLOSSEX**
- POROX**
- LIMPIADOR**
- RESIPOX**
- TTTTTT**

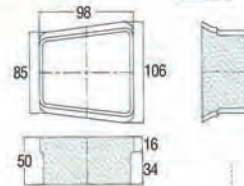

16



FRANKFURT SYNTER

CODE 05F

1p = 0,61 Kg
36p = 22,5 Kg

LIGANTES DISPONIBLES:

- SYNTER**

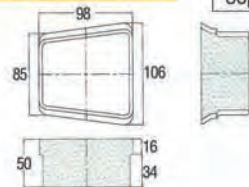

FRANKFURT PLUS

CODE 05P

1p = 0,82 Kg
24p = 20,2 Kg

LIGANTES DISPONIBLES:

- VELOX**
- GLOSSEX**
- RESIPOX**
- POROX**
- TTTTTT**

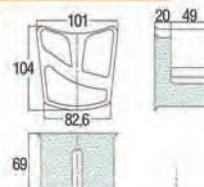

BIG FRANKFURT

CODE 05D

1p = 0,84 Kg
24p = 20,6 Kg

LIGANTES DISPONIBLES:

- VELOX**
- GLOSSEX**
- RESIPOX**
- POROX**

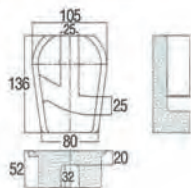

FRANKFURT POMEX

CODE 05E

1p = 0,15 Kg
36p = 6 Kg

LIGANTES DISPONIBLES:

- POMEX**



Tabla de equivalencias. - Grit Size equivalences

	000	00	0	45	1	A	C	2	F	K	3	H	N	4	5	6	7	8	10	12	15	18
FEPA	16	24	30	46	60	80	100	120	150	180	220	240	280	400	500	600	700	800	1000	1200	1500	1800

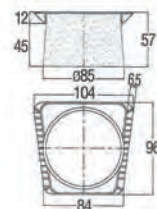

RADIAL CH-B

CODE 07E

1p = 5 Kg
4p = 20 Kg

LIGANTES DISPONIBLES:

VELOX

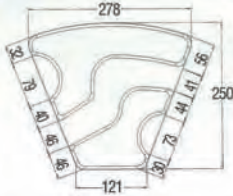

RADIAL CH-S

CODE 07F

1p = 2,80 Kg
8p = 22,4 Kg

LIGANTES DISPONIBLES:

VELOX

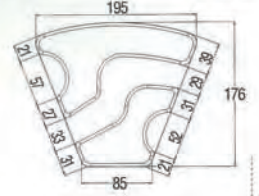

18



RADIAL LG-B

CODE 07G

1p = 3,90 Kg
4p = 15,6 Kg

LIGANTES DISPONIBLES:

VELOX

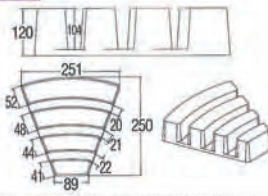

RADIAL LG-S

CODE 07H

1p = 2,20 Kg
8p = 17,6 Kg

LIGANTES DISPONIBLES:

VELOX

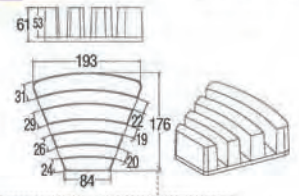

H-140 SATINEX

CODE 06K

LIGANTES DISPONIBLES:

SATINEX

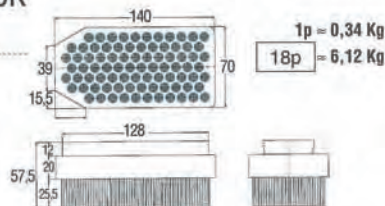

1p = 0,34 Kg
18p = 6,12 Kg



FRANKFURT SATINEX

CODE 15Z

LIGANTES DISPONIBLES:

SATINEX

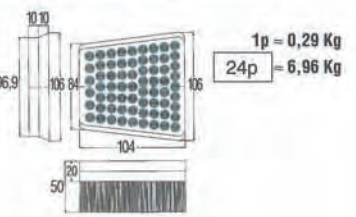

1p = 0,29 Kg
24p = 6,96 Kg

Tabla de equivalencias. - Grit Size equivalences

	000	00	0	45	1	A	C	2	F	K	3	H	N	4	5	6	7	8	10	12	15	18
FEPA	16	24	30	46	60	80	100	120	150	180	220	240	280	400	500	600	700	800	1000	1200	1500	1800



RADIAL CH-B

CODE 07E

1p = 5 Kg
4p = 20 Kg

LIGANTES DISPONIBLES:

VELOX

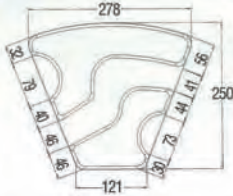

RADIAL CH-S

CODE 07F

1p = 2,80 Kg
8p = 22,4 Kg

LIGANTES DISPONIBLES:

VELOX

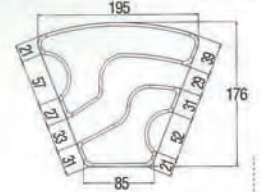

18



RADIAL LG-B

CODE 07G

1p = 3,90 Kg
4p = 15,6 Kg

LIGANTES DISPONIBLES:

VELOX

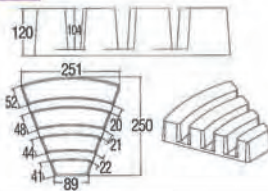

RADIAL LG-S

CODE 07H

1p = 2,20 Kg
8p = 17,6 Kg

LIGANTES DISPONIBLES:

VELOX

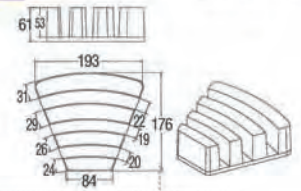

H-140 SATINEX

CODE 06K

LIGANTES DISPONIBLES:

SATINEX

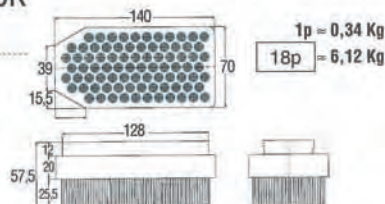

1p = 0,34 Kg
18p = 6,12 Kg



FRANKFURT SATINEX

CODE 15Z

LIGANTES DISPONIBLES:

SATINEX

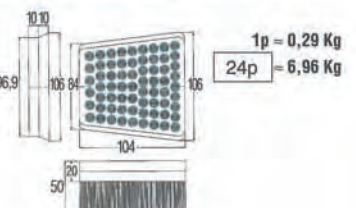

1p = 0,29 Kg
24p = 6,96 Kg

Tabla de equivalencias. - Grit Size equivalences

	000	00	0	45	1	A	C	2	F	K	3	H	N	4	5	6	7	8	10	12	15	18
FEPA	16	24	30	46	60	80	100	120	150	180	220	240	280	400	500	600	700	800	1000	1200	1500	1800



D-140-F3 "10"

CODE 8F3

1p = 1,82 Kg

LIGANTES DISPONIBLES:

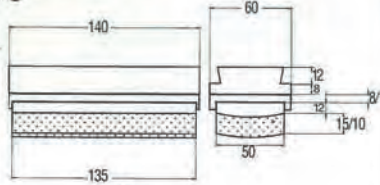

D-140-F3 "15"

CODE 8F3

1p = 2,07 Kg

LIGANTES DISPONIBLES:

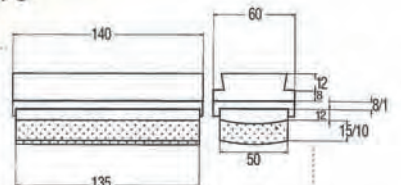

20



FRANKFURT/11

CODE 85M

1p = 1,22 Kg

LIGANTES DISPONIBLES:

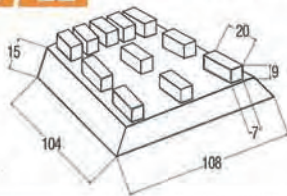

RODILLO 650x238/5

CODE 86R

1p = 54 Kg

LIGANTES DISPONIBLES:

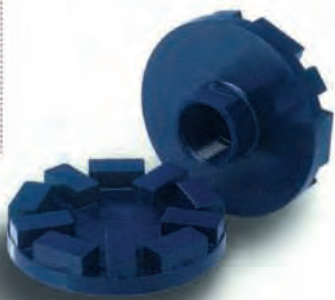
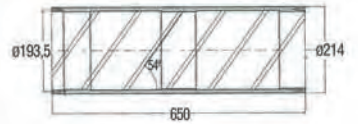

CORONA 150/10

CODE 87F

1p = 2,95 Kg

LIGANTES DISPONIBLES:

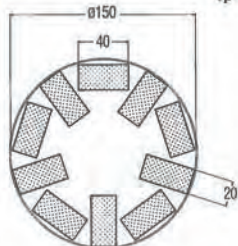

ROLLER SP6 VEL

CODE 88V

1p = 6,25 Kg

LIGANTES DISPONIBLES:



Tabla de equivalencias. - Grit Size equivalences

	000	00	0	45	1	A	C	2	F	K	3	H	N	4	5	6	7	8	10	12	15	18
FEPA	16	24	30	46	60	80	100	120	150	180	220	240	280	400	500	600	700	800	1000	1200	1500	1800

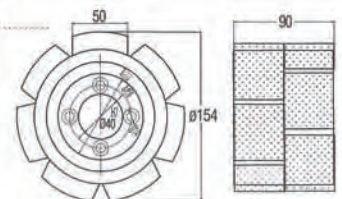

D-140-F3 "10"

CODE 8F3

1p = 1,82 Kg

LIGANTES DISPONIBLES:

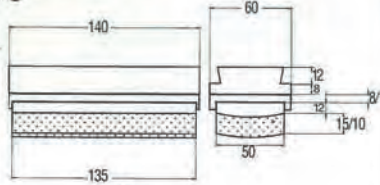

D-140-F3 "15"

CODE 8F3

1p = 2,07 Kg

LIGANTES DISPONIBLES:

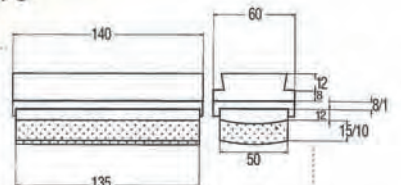

20



FRANKFURT/11

CODE 85M

1p = 1,22 Kg

LIGANTES DISPONIBLES:

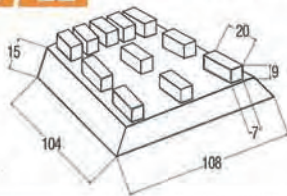

RODILLO 650x238/5

CODE 86R

1p = 54 Kg

LIGANTES DISPONIBLES:

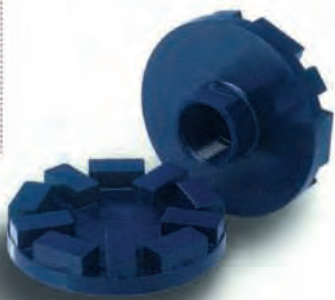
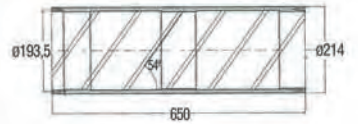

CORONA 150/10

CODE 87F

1p = 2,95 Kg

LIGANTES DISPONIBLES:

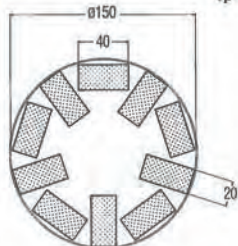

ROLLER SP6 VEL

CODE 88V

1p = 6,25 Kg

LIGANTES DISPONIBLES:



Tabla de equivalencias. - Grit Size equivalences

	000	00	0	45	1	A	C	2	F	K	3	H	N	4	5	6	7	8	10	12	15	18
FEPA	16	24	30	46	60	80	100	120	150	180	220	240	280	400	500	600	700	800	1000	1200	1500	1800

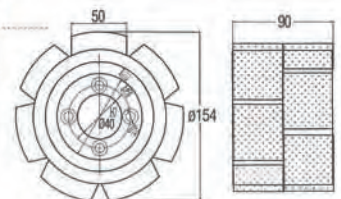

22

100 BLOC

despiece

Top bolt
Bulón sujeción H1A01

Cuerpo H1A02
Top plate

Spring
Muelle H1A03

Aro sujeción H1A04
Botton plate

Allen screws
Tornillo allen H1A05

Aro desbloqueo H1A06
Disc

Junta tórica H1A07
Washer

Anillo seeger H1A08
Spring cup

Lever
Llave desbloqueo H1A11

Llave montaje H1A10
Spanner

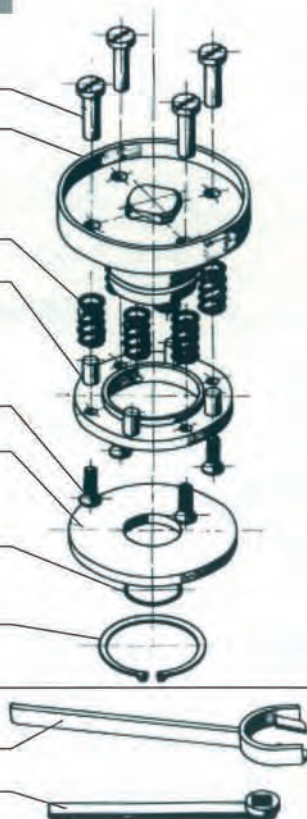

125 BLOC 160 BLOC

despiece

Top bolt
Bulón sujeción H2E01

Cuerpo H2E02
Top plate

Spring
Muelle H2E03

Aro sujeción H2E04
Botton plate

Allen screws
Tornillo allen H2E05

Aro desbloqueo H2E06
Disc

Junta tórica H2E07
Washer

Anillo seeger H2E08
Spring cup

Lever
Llave desbloqueo H2E11

Llave montaje H2E10
Spanner

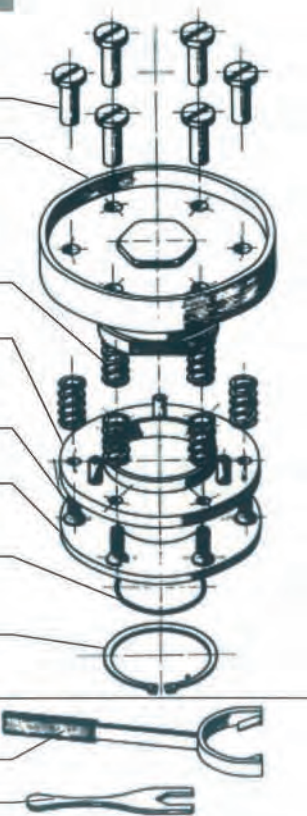



Barcelonès, 39
Polígono Ind. El Ramassar
08520 Les Franqueses del Vallès
BARCELONA (SPAIN)
P.O. Box 197 - 08400 Granollers (Spain)
Oficina Tel. (34) 93. 846.58.75
Fax: (34) 93. 846 80 29
Fábrica y Almacén Tel. (34) 93. 846 44 02
Fax:(34) 93. 840 10 18
ae.abressa@abressa.com



Octavio Lacante Pallisson s/n
Polígono Ind. Can Magarola
08100 Mollet del Vallès
P.O. Box 94 - 08100 Mollet del Vallès
Tels.(34) 93. 570 30 87 - (34) 93. 570 31 23
Fax. (34) 93. 570 30 82
ace.abressa@abressa.com



408, Rue Principale
St.Sebastien
QUEBEC
CANADA GOY 1 MO
Tel. (1) 819. 652 27 72
Fax. (1) 819. 652 27 73
aca.abressa@abressa.com



Zona Industrial, 2
Campos
4920 VILA NOVA DE CERVEIRA
PORTUGAL
Tel. (351) 251 79 68 54
Fax. (351) 251 79 68 53
ap.abressa@abressa.com

Distributore esclusivo:



Via Chiavornico, 10 Z.I. - 33084 CORDENONS (PN) - Tel. 0434 540022 - Fax 0434 541967

www.marmotech.com

info@marmotech.com